

nomon
JEWELRY FOR HOME



Lighting Collection

Warm lamps, whether
they are switched on or off.

Our goal is to create
warm lamps, whether they
are switched on or off.

Nuestro objetivo es crear lámparas cálidas,
tanto encendidas como apagadas.

LIGHTING COLLECTION

Our lamp collections stand out for their use of wood and warm materials, always handcrafted in Barcelona. We design lamps dressed in noble materials, intended to create warm and elegant atmospheres in both public and residential interior design projects.

Our goal is to create warm lamps, whether they are switched on or off.

Nuestras colecciones de lámparas destacan por el uso de la madera, trabajada de forma artesanal en Barcelona. Diseñamos lámparas vestidas con materiales nobles, destinadas a crear atmósferas cálidas y elegantes en proyectos de interiorismo públicos y residenciales.

Nuestro objetivo es crear lámparas cálidas, tanto encendidas, como apagadas.



NEW · CATAY COLLECTION



NEW · AUTUMN COLLECTION



NEW · TAMÍZ COLLECTION



ONFA COLLECTION

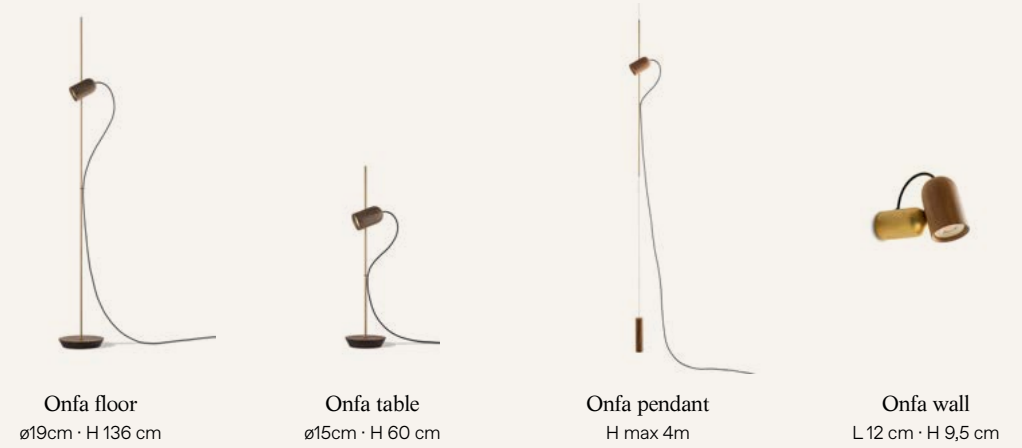

LÍNEA COLLECTION



WOODEN DOTS COLLECTION

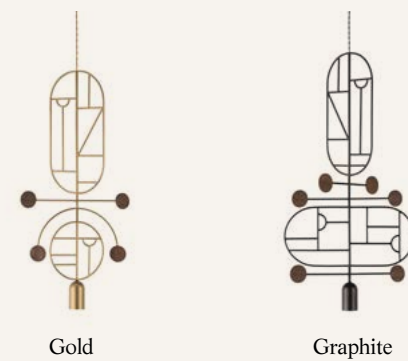

Catay Collection

Goula Figuera

Catay is the name of this collection that combines the elegance of natural wood with the warmth of parchment, which casts a diffused and gentle light.

Catay es el nombre de esta colección que combina la elegancia de la madera natural con la calidez del pergamino que proyecta una luz delicada y acogedora.



Catay portable outdoor
ø15cm · H 30 cm



Catay portable
ø15cm · H 30 cm



Catay M
ø22cm · H 44 cm



Catay XL
ø45cm · H 87 cm



CATAY PORTABLE

ø15cm · H 30 cm



A new version of the Catay collection, now in a portable format, designed to adapt naturally to different spaces and uses. It stands out for its solid wood handle located at the top, an element that serves a triple function: structural support, handle and decorative detail, adding character and warmth to the whole. An elegant lamp, now far more versatile and free to move.

Una nueva versión de la colección Catay ahora en formato portátil, pensada para adaptarse con naturalidad a distintos espacios y usos. Destaca por su asa de madera maciza situado en la parte superior, un elemento que cumple una triple función: estructura, mango y detalle decorativo, aportando carácter y calidez al conjunto. Una lámpara elegante y mucho más versátil ahora libre de movimiento.





CATAY PORTABLE OUTDOOR

ø15cm · H 30 cm



The careful selection of materials, together with its IP65 LED module, provides protection against different weather conditions. The iroko wood handle and the PVC shade allow the lamp to adapt to all kinds of outdoor spaces, from terraces and restaurants to contract environments.

La cuidada selección de materiales, junto con su módulo LED IP65, le aporta protección para las distintas condiciones climáticas. El asa de madera de iroko y la pantalla de PVC permiten que la lámpara se adapte a todo tipo de espacios exteriores, desde terrazas, restaurantes y ambientes contract.



CATAY M

ø22cm · H 44 cm



The design of Catay, created by Goula Figuera studio, is available in table, floor and portable outdoor and indoor versions.

El diseño de Catay, obra del estudio Goula Figuera, está disponible en versión de sobremesa, pie o portátil tanto de interior como de exterior.





Both its minimalist design and its warm, enveloping light make it an ideal lamp not only for the home, but also for hospitality projects.

Tanto su diseño minimalista como su luz cálida y envolvente, la hacen una lámpara ideal no solo para el hogar, sino también para proyectos hospitality.

CATAY XL

ø45 cm · H 87 cm



The collection stands out for striking a balance between a minimalist, contemporary form, and an oriental-inspired aesthetic, handcrafted with an impeccable finish.

La colección destaca por encontrar el equilibrio entre una forma minimalista y contemporánea con una estética de inspiración oriental, de fabricación artesanal y acabado impecable.



Autumn Collection

Andrés Martínez

The Autumn collection is characterized by filtering light through natural wood shades, creating a warm and serene atmosphere that transports us to a cozy autumn afternoon.

La colección Autumn se caracteriza por filtrar la luz a través de láminas de madera natural, creando una atmósfera cálida y serena que nos transporta a una hogareña tarde de otoño.



Autumn table
ø40cm · H 60 cm



Autumn floor
ø40cm · H 150 cm



Autumn pendant
ø40cm · H max 250 cm



Autumn wall
L 22 cm · H 24 cm



AUTUMN TABLE

ø40cm · H 60 cm



A lamp ideal for adding character,
perfect for sideboards or office desks.

Una lampara ideal para dar personalidad
y colocar encima de bufets o mesas de despacho.





AUTUMN FLOOR

ø40cm · H 150 cm



Its walnut wood structure and brass details, together with the perforated wooden shade, turn it into a sophisticated lamp in which every detail has been carefully considered.

Su estructura de madera de nogal y detalles en latón junto con la pantalla de madera troquelada la convierte en una lámpara sofisticada donde todo está cuidado al detalle.

AUTUMN PENDANT

ø40cm · H max 250 cm



The character of the pendant version lies in the effect created by the perforated wooden shade. When switched off, it still commands attention, presenting a delicate object with a strong visual identity.

La personalidad de la versión colgante reside en el efecto que genera la pantalla troquelada de madera. Apagada, mantiene su presencia, mostrando un objeto delicado con una fuerte identidad visual.





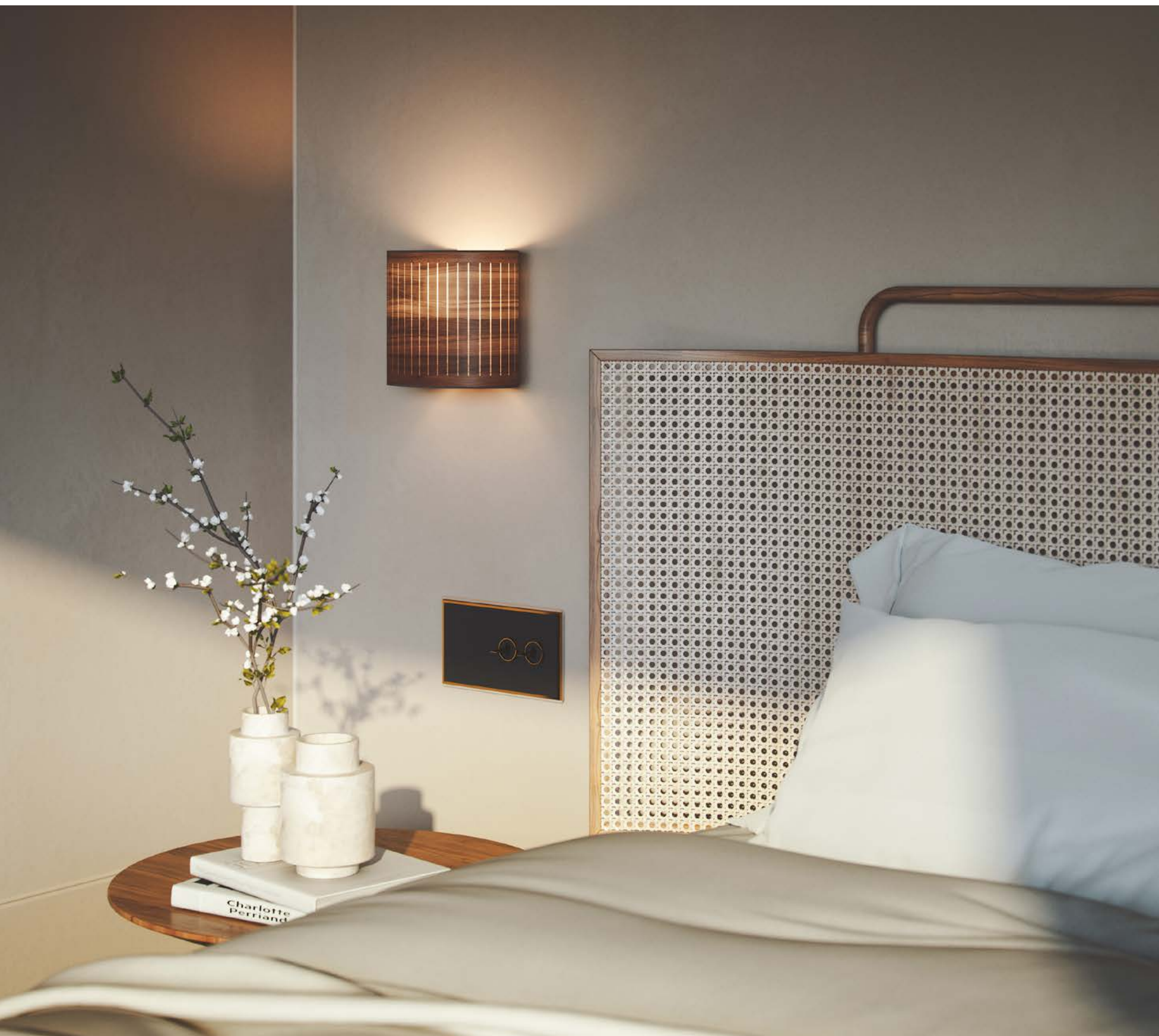

AUTUMN WALL

L 22 cm · H 24 cm

The wall-mounted version allows installation in spaces such as hallways, bedrooms, or transitional areas.

La versión de aplique permite su instalación en espacios como pasillos, dormitorios o zonas de paso.



A discreet and elegant solution that
provides ambient light without losing
the distinctive character of the collection.

Una solución discreta y elegante que aporta luz
ambiental sin perder el carácter distintivo de la familia.

Tamíz Collection

Andrés Martínez

Tamíz fuses the warmth of translucent wood shade with the softness of fabrics, creating lamps that filter light in a unique way.

Tamíz fusiona la calidez de las hojas de madera translúcida con la suavidad de las telas, creando lámparas que filtran la luz de una manera única.



Tamíz pie
ø35cm · H 150 cm



Tamíz L
ø35cm · H 102 cm



Tamíz M
ø22cm · H 62 cm



Tamíz pendant
ø35cm · H max 250 cm



Tamíz pendant M
ø22cm · H max 250 cm





TAMÍZ PIE

ø35cm · H 150 cm



The floor-standing version features a walnut structure supporting the linen and wood shade. It is a highly functional lamp for spacious areas.

La versión de pie está compuesta por una estructura en nogal que sostiene la pantalla de lino y madera. Es una lámpara muy funcional para espacios amplios.



TAMÍZ L / M

ø35cm · H 102 cm / ø22cm · H 62 cm



Placed directly on the floor without the need for a base, it adapts easily to any space. Works perfectly next to armchairs or reading corners, and by combining the two sizes, you can create harmonious lighting points in large rooms or gathering areas.

Se coloca directamente sobre el suelo, sin necesidad de pie, adaptándose fácilmente a cualquier espacio. Funciona muy bien junto a sillones o rincones de lectura. Combinando los dos tamaños, son ideales para salas amplias o áreas de encuentro.

TAMÍZ PENDANT

ø35cm · H max 250 cm



The chandelier format creates a warm and inviting atmosphere, ideal for hospitality projects.

El formato chandeliera genera una atmósfera envolvente y acogedora, ideal para proyectos hospitality.





TAMÍZ PENDANT M

ø22cm · H max 250 cm

Its compact size makes this version perfect for smaller rooms or areas where central lighting is needed without overwhelming the space. Works well over tables, in entryways, or grouped with several units for balanced and pleasant illumination.

El tamaño reducido de esta versión la hace perfecta para habitaciones más pequeñas o zonas donde se necesita una luz central sin recargar el ambiente. Funciona muy bien sobre mesas, en recibidores o agrupada con varias unidades para una iluminación equilibrada y agradable.

Onfa Collection

Goula Figuera

The Onfa models involves an ingenious technique with magnet, that allows us to easily direct the light.

La Colección de lámparas Onfa incorpora una ingeniosa idea basada en un imán, que permite enfocar y dirigir la luz fácilmente.



Onfa floor
ø19cm · H 136 cm



Onfa table
ø15cm · H 60 cm



Onfa pendant
H max 4m



Onfa wall
L 12 cm · H 9,5 cm





ONFA FLOOR

ø19cm · H 136 cm

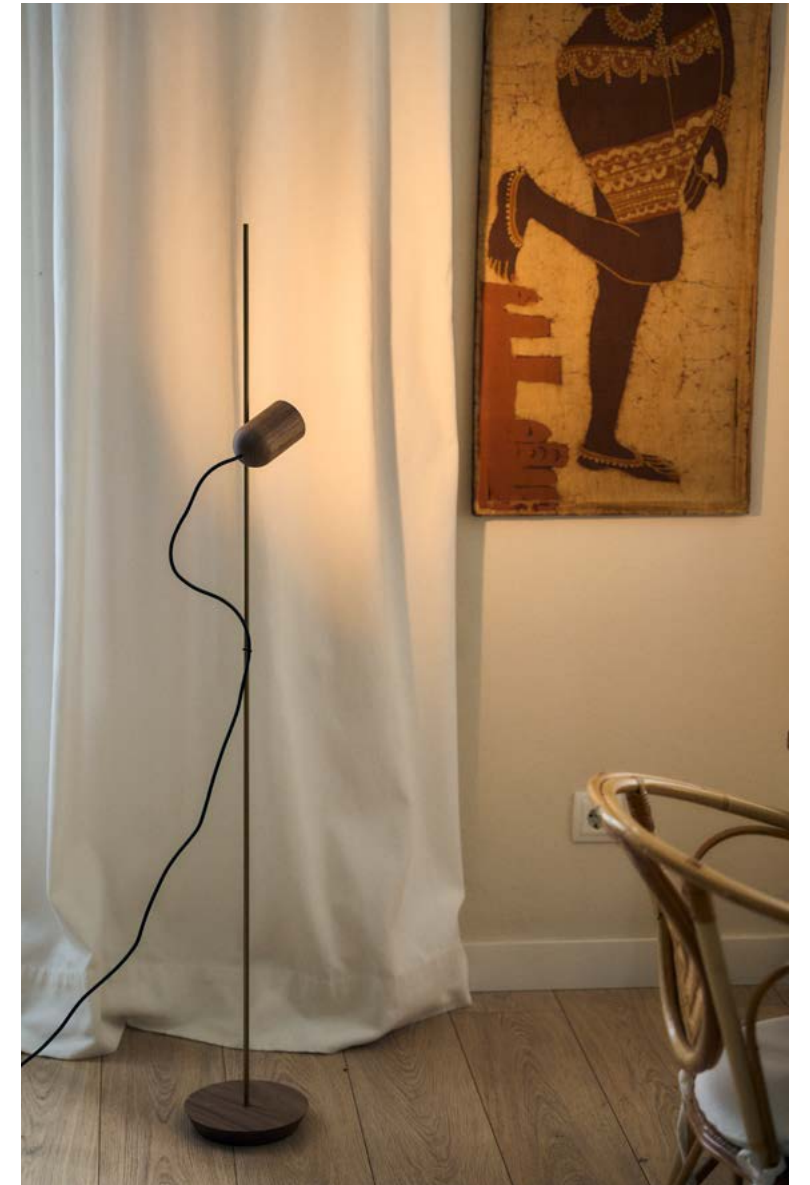

We design lamps dressed in noble materials,
intended to create warm and elegant atmospheres.

Diseñamos lámparas vestidas con materiales
nobles, destinadas a crear atmósferas cálidas.

ONFA TABLE

ø15cm · H 60 cm



Beyond its function as a luminaire, the collection provides a sense of warmth that appeals to rest and reflection.

Más allá de su función como luminaria, la colección proporciona una sensación de calidez que invita al descanso y la reflexión.





Our design reflects creativity with a great sense of refinement.

Nuestro diseño refleja creatividad
con un profundo sentido del refinamiento.



ONFA PENDANT

H max 4m



A slender steel cable, finished with a wooden and metal counterweight, supports the pendant version from the ceiling. A refined yet functional lamp.

Un fino cable de acero, rematado con un contrapeso de madera y metal sostienen desde el techo la versión colgante. Una lámpara refinada al mismo tiempo funcional.



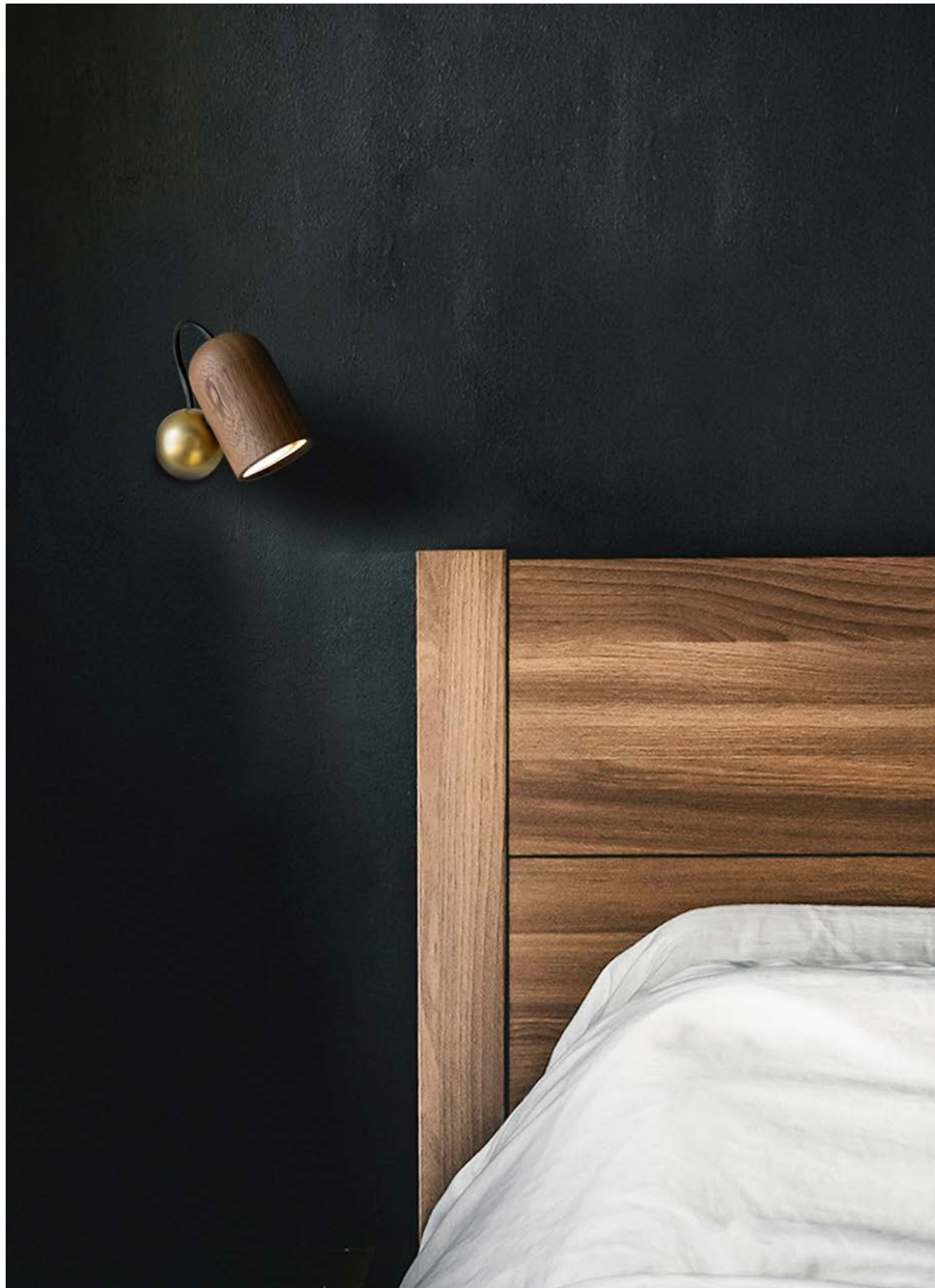

ONFA WALL

L 12 cm · H 9,5 cm



A wall light with a magnetic wooden head, allowing complete freedom of orientation to direct the light in any direction. Its clever design makes it an ideal lamp for a bedside table.

Aplique con cabezal de madera imantado, que permite una libertad total de orientación para dirigir la luz en cualquier dirección. Su ingenioso diseño la convierte en una lámpara ideal como cabecera de cama.

Línea Collection

Andrés Martínez

Delicate and light design collection where the warmth of wood wraps a cozy ambient lighting.

Es una colección de diseño delicado y ligero donde la calidez de la madera viste una luz de ambiente acogedora.



Línea H
L 125 cm · H max 200 cm



Línea V
H 125 cm · H max 200 cm



Línea D
L 65 cm · H 150 cm



Línea Uno
ø32cm · H 167 cm

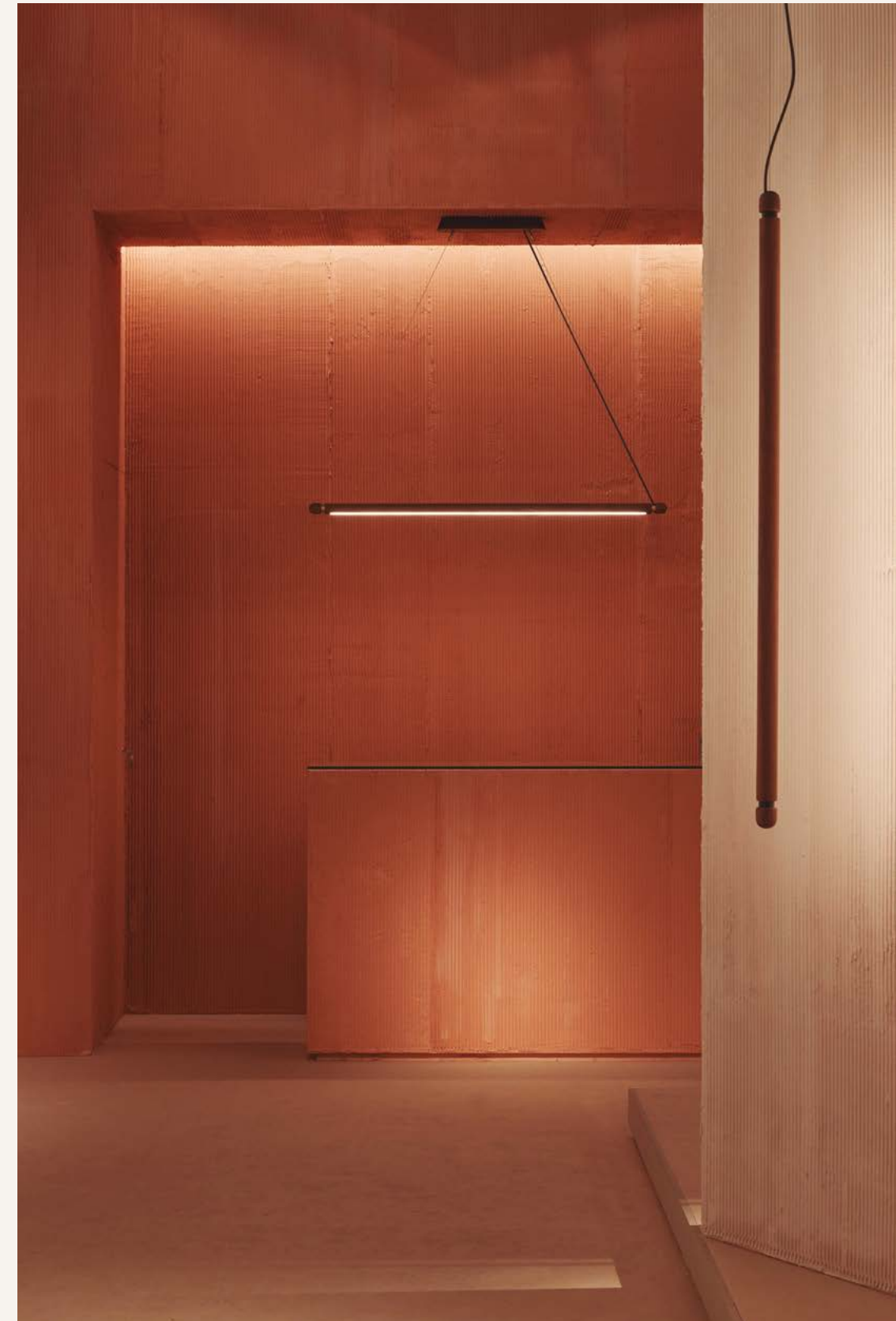



LÍNEA H

L 125 cm · H max 200 cm

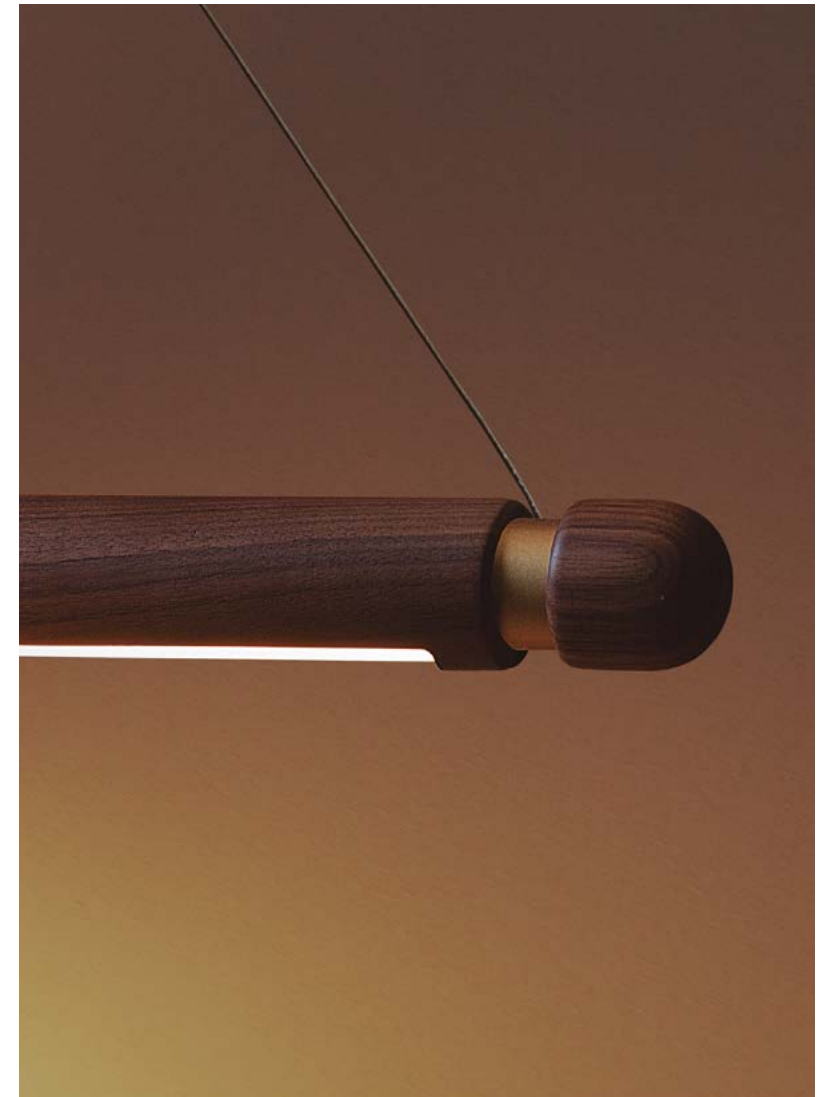

Its design consists of a turned wooden body that houses an integrated LED system, finished with polished brass detailing. It is intended to be placed on a dining table or a counter.

Su diseño consiste en un cuerpo de madera torneada que aloja un sistema de LED integrado, rematado con detalles en latón pulido. Pensada para colocarse encima de una mesa de comedor o un mostrador.

LÍNEA V

H 125 cm · H max 200 cm



Pendant version designed for narrow spaces such as corridors, as well as for chandeliers in stairwells or hotel lobbies.

Versión colgante ideal para espacios estrechos como pasillos, así como para chandeliers para huecos de escalera o halls de hotel.

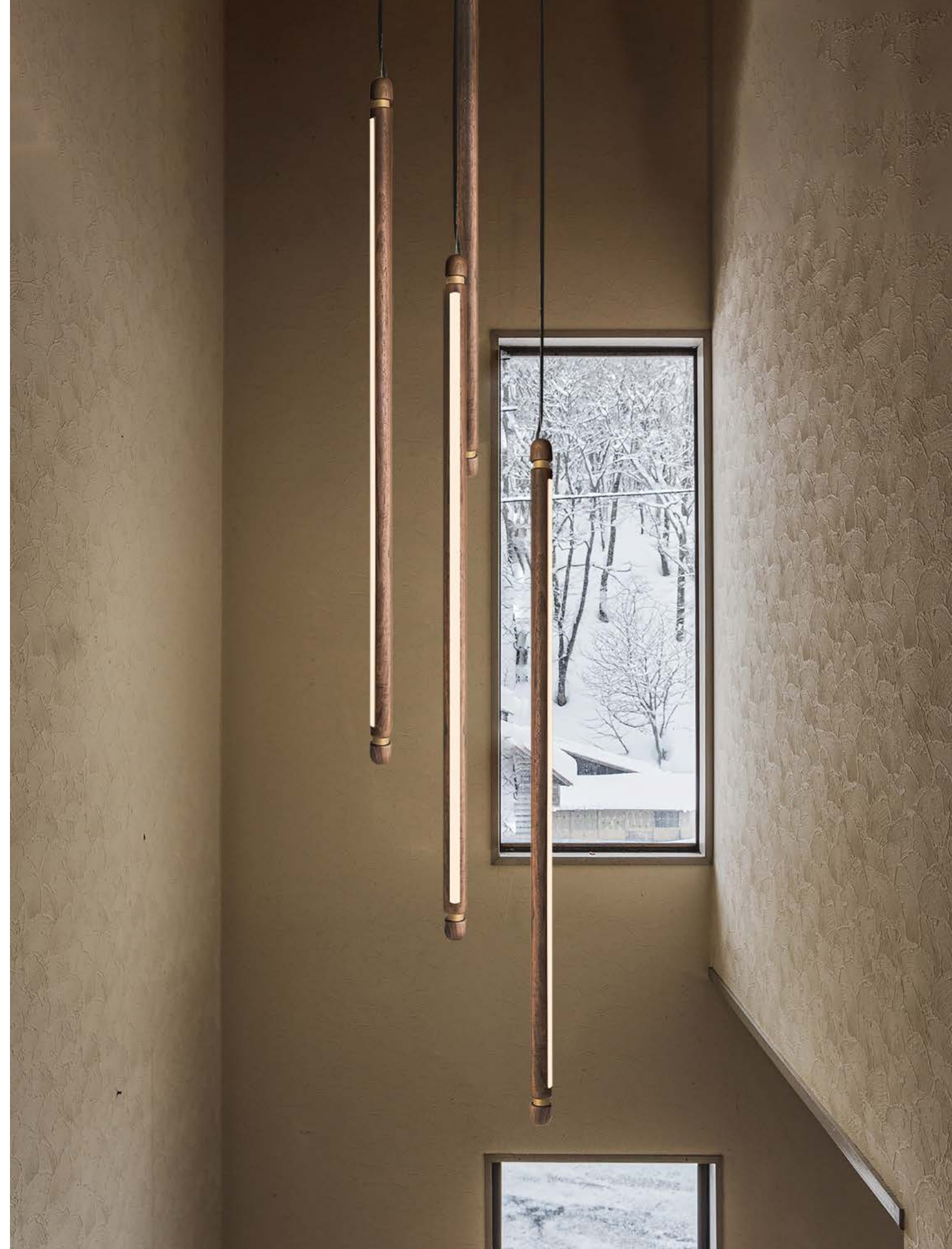



LÍNEA D

L 65 cm · H 150 cm



Sculptural floor lamp of warm and indirect ambient light.
It creates an intimate and enveloping atmosphere.

Escultórica lámpara de pie de luz ambiental cálida e indirecta,
creando una atmosfera íntima y envolvente.

LÍNEA UNO

∅32cm · H 167 cm



Floor lamp that combines a marble base and turned walnut body. A design of exquisite simplicity.

Lámpara de pie que combina base de mármol y cuerpo de nogal torneado. Un diseño de exquisita simplicidad.



Wooden Dots Collection

Goula Figuera

A lamp collection full of personality. Composed of a set of bodies with unique shapes that have their own graphic language and character, individually or combined with each other.

Colección de lámparas que destaca por su personalidad. Compuesta por un conjunto de cuerpos con formas singulares que individualmente o combinados entre si tienen un lenguaje gráfico propio y con carácter.

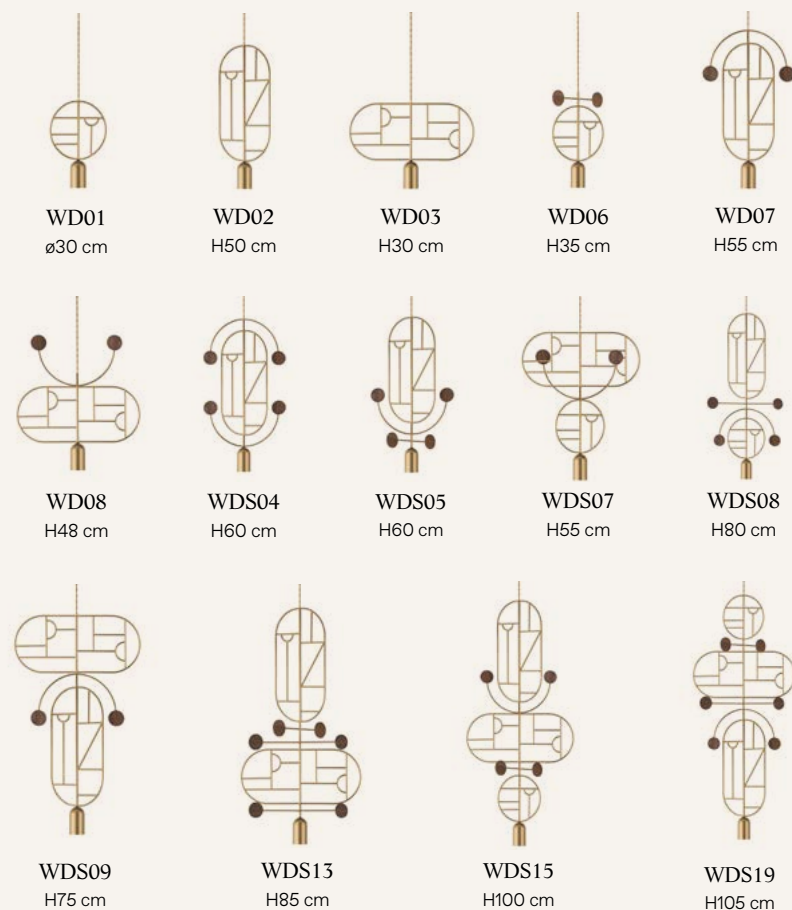

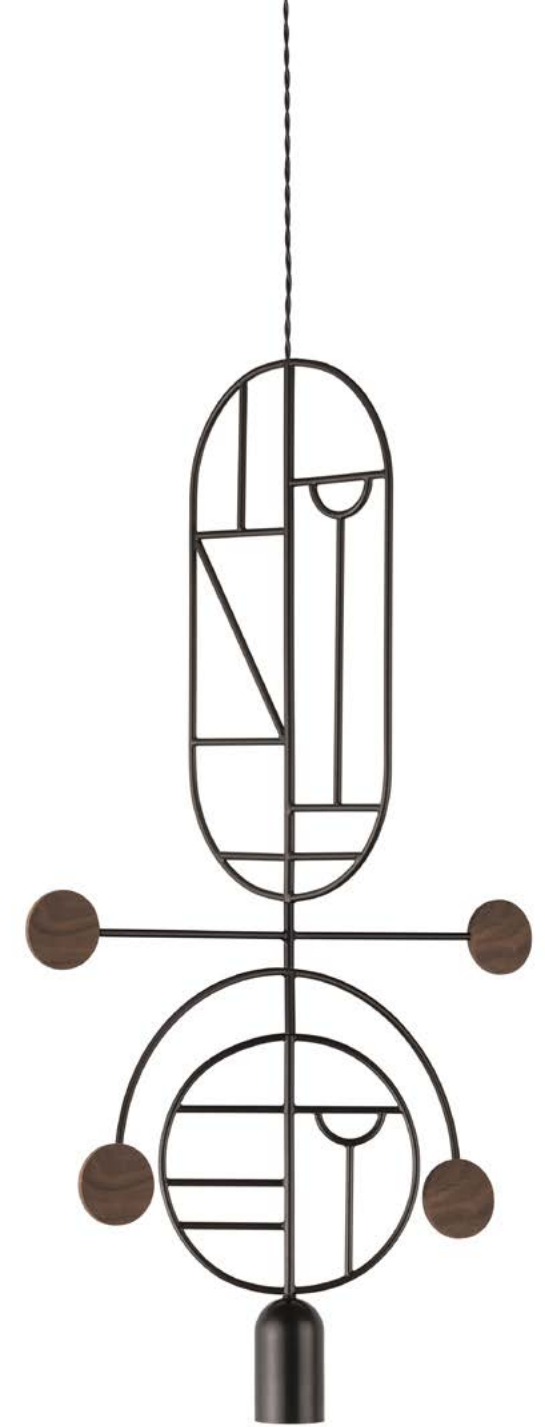

WDS 08

H 80cm

Models available in brass or graphite finished metal with circular details in walnut or color.

Modelos disponibles en metal acabado dorado o grafito y detalles circulares en nogal o color.



WDS 05

H 60cm

Sculptural luminaire that creates a striking contrast between shadow and light, with strong personality and graphic character. Its graphite or gold metal lampholder houses a GU10 bulb that emits a warm light.

Luminaria escultórica que crea contraste entre sombras y luz, con gran personalidad y carácter gráfico. Su casquillo metálico dorado o grafito contiene una bombilla GU10 que emite una luz cálida.



Project - Studio Eigen
Photo - Francesca Vinci

CUSTOM & SPECIAL PRODUCTS

We adapt our products to the needs of each project, offering a range of finishes, materials and dimensions so that every piece integrates coherently within its environment.

Adaptamos nuestros productos a las necesidades de cada proyecto, ofreciendo distintas opciones de acabados, materiales y medidas para que cada pieza se integre con coherencia en su entorno.



TECHNICAL INFORMATION - LIGHTING

AUTUMN TABLE

MODEL	REF.
Structure: Natural solid walnut / Brass finished metal Lampshade: Natural wood shade with a walnut finish Cuerpo: Madera de nogal natural / Metal acabado latón Pantalla: Hoja de madera natural acabado nogal	AUTMNG

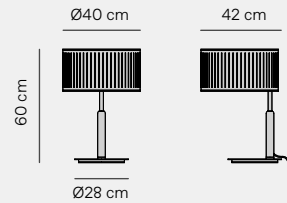

AUTUMN FLOOR

MODEL	REF.
Structure: Natural solid walnut / Brass finished metal Lampshade: Natural wood shade with a walnut finish Cuerpo: Madera de nogal natural / Metal acabado latón Pantalla: Hoja de madera natural acabado nogal	AUTNG

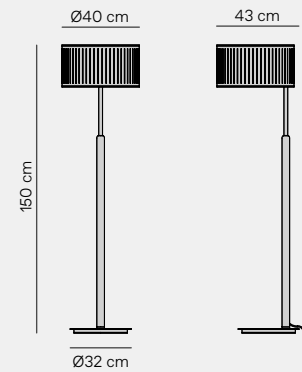

AUTUMN PENDANT

MODEL	REF.
Lampshade: Natural wood shade with a walnut finish Pantalla: Hoja de madera natural acabado nogal	AUTPNG

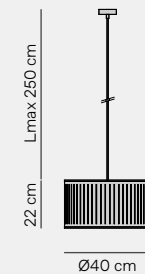

AUTUMN WALL

MODEL	REF.
Lampshade: Natural wood shade with a walnut finish Pantalla: Hoja de madera natural acabado nogal	AUTWNG

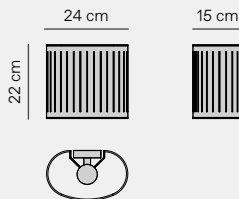

Non-dimmable (ON-OFF) or Dimmable (dimmer included)
BULB: LED E27 (included)
Input voltage / Frequency: 100 - 240 V / 50 - 60 Hz
Wattage 11 W
Lumens: 1521 lm / Angle: 360° (recommended)
Colour Temperature: 2700K



CATAY PORTABLE

MODEL	REF.	Finishes / Acabado
Catay portable walnut	CATPNI	Natural solid walnut wood / Lampshade parchment Madera maciza de nogal natural/ Pantalla: Pergamino
Catay portable black ash	CATPBI	Black stained ash / Lampshade parchment Fresno teñido negro / Pantalla: Pergamino
Catay portable oak	CATPRI	Natural solid oak wood / Lampshade parchment Madera maciza de roble natural/ Pantalla: Pergamino

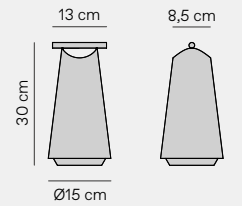

CATAY PORTABLE OUTDOOR

MODEL	REF.	Finishes / Acabado
Catay portable outdoor	CATPIE	Base ABS / Natural Solid Iroko wood / Lampshade: PVC Base de ABS / Madera maciza de Iroko natural / Pantalla: PVC

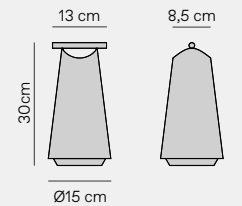

ELECTRICAL SPECIFICATIONS

LED: DC 5V, 2700K 5W CR180
416LM(module) 386LM(valid)
Input DC 5V 2A (exclude adaptor)
Battery type: 3.7V 5200mAh
Class III · IP65

Charging time: 6 hours
Working time: 10-14 hours
Type C-USB charging cable in white (included)



CATAY M

MODEL	REF.	Finishes / Acabado
Catay M walnut	CATMNG	Natural solid walnut wood / Lampshade parchment Madera maciza de nogal natural/ Pantalla: Pergamino
Catay M black ash	CATMB	Black stained ash / Lampshade parchment Fresno teñido negro / Pantalla: Pergamino
Catay M oak	CATMR	Natural solid oak wood / Lampshade parchment Madera maciza de roble natural/ Pantalla: Pergamino

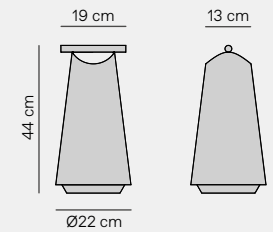

CATAY XL

MODEL	REF.	Finishes / Acabado
Catay XL walnut	CATNG	Natural solid walnut wood / Lampshade parchment Madera maciza de nogal natural/ Pantalla: Pergamino
Catay XL black ash	CATB	Black stained ash / Lampshade parchment Fresno teñido negro / Pantalla: Pergamino
Catay XL oak	CATR	Natural solid oak wood / Lampshade parchment Madera maciza de roble natural/ Pantalla: Pergamino

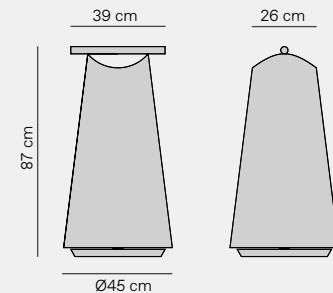

Non-dimmable (ON-OFF) or Dimmable (dimmer included)
BULB: LED E27 (included)
Input voltage / Frequency: 100 - 240 V / 50 - 60 Hz
Wattage 11 W
Lumens: CATAY M (1521 lm) CATAY XL (2300 lm) / Angle: 360° (recommended)
Colour Temperature: 2700K



TAMÍZ PIE

MODEL	REF.
Body: Natural solid walnut / Brass finished metal Lampshade: Fabric and natural wood shades with a walnut finish Cuerpo: Madera maciza de nogal natural/ Metal acabado latón Pantalla: Tela y hojas de madera acabado nogal	TAMNG

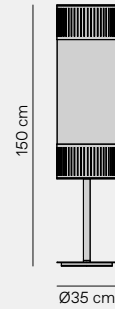

TAMÍZ L

MODEL	REF.
Lampshade: Fabric and natural wood shades with a walnut finish Pantalla: Tela y hojas de madera acabado nogal	TAMLN



TAMÍZ M

MODEL	REF.
Lampshade: Fabric and natural wood shades with a walnut finish Pantalla: Tela y hojas de madera acabado nogal	TAMMN

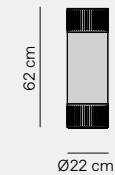

TAMÍZ PENDANT

MODEL	REF.
Lampshade: Fabric and natural wood shades with a walnut finish Pantalla: Tela y hojas de madera acabado nogal	TAMPNG

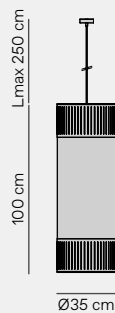

TAMÍZ PENDANT M

MODEL	REF.
Lampshade: Fabric and natural wood shades with a walnut finish Pantalla: Tela y hojas de madera acabado nogal	TAMPMN

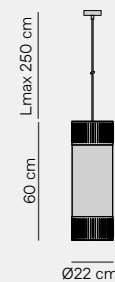

TAMÍZ CHANDELIER - RECOMMENDED CONFIGURATIONS

TAMÍZ CHANDELIER 2	REF. CHTAPN2
Cable to canopy Cable a florón	
STRUCTURE	Walnut wood plate screwed to the ceiling. Plato de madera de nogal atornillado a techo.
CANOPY	Single canopy Unico florón
WEIGHT	8kg / 17.6 lb
MODELS	x2 Tamiz Pendant

*Under request

TAMÍZ CHANDELIER 3	REF. CHTAPN3
Cable to canopy Cable a florón	
STRUCTURE	Walnut wood plate screwed to the ceiling. Plato de madera de nogal atornillado a techo.
CANOPY	Single canopy Unico florón
WEIGHT	10 kg / 22 lb
MODELS	x3 Tamiz Pendant

*Under request

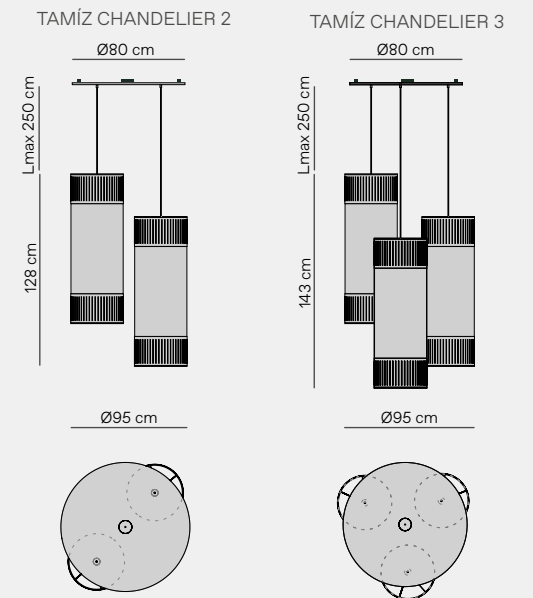

TAMÍZ PENDANT M - CHANDELIER CONFIGURATIONS

TAMÍZ M CHANDELIER 2	REF. CHTAPMN2
Cable to canopy Cable a florón	
STRUCTURE	Walnut wood plate screwed to the ceiling. Plato de madera de nogal atornillado a techo.
CANOPY	Single canopy Unico florón
WEIGHT	4kg / 8.8 lb
MODELS	x2 Tamiz M Pendant

*Under request

TAMÍZ M CHANDELIER 3	REF. CHTAPMN3
Cable to canopy Cable a florón	
STRUCTURE	Walnut wood plate screwed to the ceiling. Plato de madera de nogal atornillado a techo.
CANOPY	Single canopy Unico florón
WEIGHT	5 kg / 11 lb
MODELS	x3 Tamiz M Pendant

*Under request

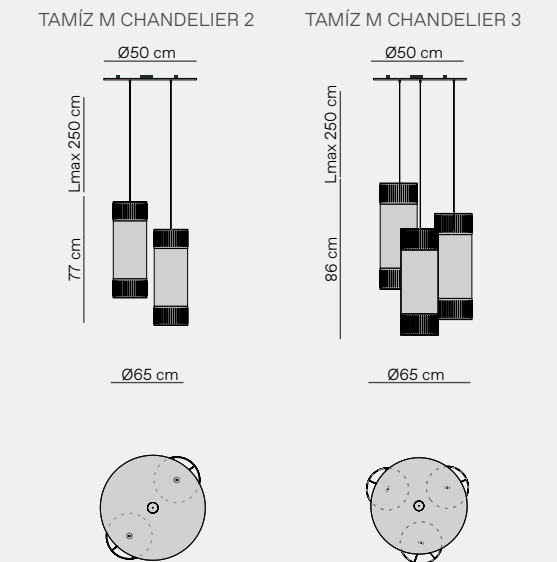

Non-dimmable (ON-OFF) or Dimmable (dimmer included)
BULB: LED E27 (included)
Input voltage / Frequency: 100 - 240 V / 50 - 60 Hz
Wattage (Pie, L, Pendant) 17 W / (M, Pendant M) 11 W
Lumens: (Pie, L, Pendant) 2452 lm / (M, Pendant M) 1521 lm / Angle: 360° (recommended)
Colour Temperature: 2700K



ONFA FLOOR

MODEL	REF.	Finishes / Acabado
Onfa floor walnut	ONFANG	Natural solid walnut wood / Brass finished metal Madera maciza de nogal natural/ Metal acabado latón
Onfa floor black ash	ONFABT	Black stained ash / Graphite finished metal Fresno teñido negro / Metal acabado grafito
Onfa floor walnut-black	ONFANT	Natural solid walnut wood / Graphite finished metal Madera maciza de nogal natural/ Metal acabado grafito
Onfa floor oak	ONFART	Natural solid oak wood / Graphite finished metal Madera maciza de roble natural / Metal acabado grafito

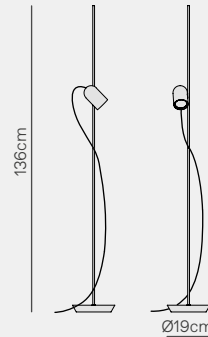

ONFA TABLE

MODEL	REF.	Finishes / Acabado
Onfa table walnut	ONFAMNG	Natural solid walnut wood / Brass finished metal Madera maciza de nogal natural/ Metal acabado latón
Onfa table black ash	ONFAMBT	Black stained ash / Graphite finished metal Fresno teñido negro / Metal acabado grafito
Onfa table walnut-black	ONFAMNT	Natural solid walnut wood / Graphite finished metal Madera maciza de nogal natural/ Metal acabado grafito
Onfa table oak	ONFAMRT	Natural solid oak wood / Graphite finished metal Madera maciza de roble natural / Metal acabado grafito

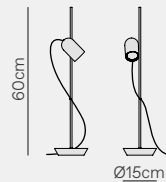

ONFA PENDANT

MODEL	REF.	Finishes / Acabado
Onfa pendant walnut	ONFAPNG	Natural solid walnut wood / Brass finished metal Madera maciza de nogal natural/ Metal acabado latón
Onfa pendant black ash	ONFAPBT	Black stained ash / Graphite finished metal Fresno teñido negro / Metal acabado grafito
Onfa pendant walnut-black	ONFAPNT	Natural solid walnut wood / Graphite finished metal Madera maciza de nogal natural/ Metal acabado grafito
Onfa pendant oak	ONFAPRT	Natural solid oak wood / Graphite finished metal Madera maciza de roble natural / Metal acabado grafito

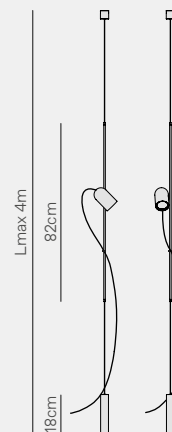

DIMMABLE (Dimmer included)
BULB: LED Reflector Par16 GU10 (included)
Input voltage / Frequency: 100 - 240 V / 50 - 60 Hz (according to destination)
Wattage: 7.5 W
Lumens: 520 lm
Colour Temperature: 2700K
Angle: 60°



ONFA WALL

MODEL	REF.	Finishes / Acabado
Onfa wall walnut	ONFAWNG	Natural solid walnut wood / Brass finished metal Madera maciza de nogal natural/ Metal acabado latón
Onfa wall black ash	ONFAWBT	Black stained ash / Graphite finished metal Fresno teñido negro / Metal acabado grafito
Onfa wall walnut-black	ONFAWNT	Natural solid walnut wood / Graphite finished metal Madera maciza de nogal natural/ Metal acabado grafito
Onfa wall oak	ONFAWRT	Natural solid oak wood / Graphite finished metal Madera maciza de roble natural / Metal acabado grafito

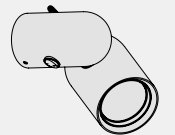
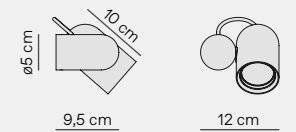

*Version with optional integrated switch
*Versión con interruptor integrado opcional

DIMMABLE (Dimmer not included)
BULB: LED Reflector Par16 GU10 (included)
Input voltage / Frequency: 100 - 240 V / 50 - 60 Hz (according to destination)
Wattage: 7.5 W
Lumens: 520 lm
Colour Temperature: 2700K
Angle: 60°



ONFA FLOOR DOUBLE SPOTLIGHT

MODEL	REF.	Finishes / Acabado
Onfa floor walnut	ONFADNG	Natural solid walnut wood / Brass finished metal Madera maciza de nogal natural/ Metal acabado latón
Onfa floor black ash	ONFADBT	Black stained ash / Graphite finished metal Fresno teñido negro / Metal acabado grafito
Onfa floor walnut-black	ONFADNT	Natural solid walnut wood / Graphite finished metal Madera maciza de nogal natural/ Metal acabado grafito
Onfa floor oak	ONFADRT	Natural solid oak wood / Graphite finished metal Madera maciza de roble natural / Metal acabado grafito

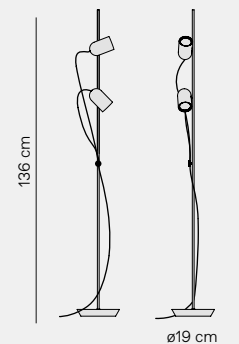

ONFA PENDANT DOUBLE SPOTLIGHT

MODEL	REF.	Finishes / Acabado
Onfa pendant walnut	ONFAPDNG	Natural solid walnut wood / Brass finished metal Madera maciza de nogal natural/ Metal acabado latón
Onfa pendant black ash	ONFAPDBT	Black stained ash / Graphite finished metal Fresno teñido negro / Metal acabado grafito
Onfa pendant walnut-black	ONFAPDNT	Natural solid walnut wood / Graphite finished metal Madera maciza de nogal natural/ Metal acabado grafito
Onfa pendant oak	ONFAPDRT	Natural solid oak wood / Graphite finished metal Madera maciza de roble natural / Metal acabado grafito

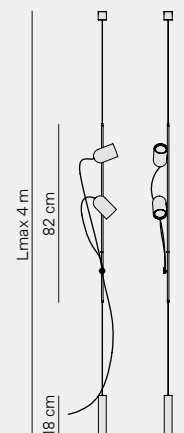

DIMMABLE (Dimmer included)
BULB: LED Reflector Par16 GU10 (included)
Input voltage / Frequency: 100 - 240 V / 50 - 60 Hz (according to destination)
Wattage: 7.5 W
Lumens: 520 lm
Colour Temperature: 2700K
Angle: 60°



LÍNEA H

MODEL	REF.	Finishes / Acabado
Línea H Walnut-Gold	LIHNGD	Natural solid walnut wood/ Brass finished metal Madera maciza de nogal natural/ Metal acabado latón
Línea H Walnut-Black	LIHNBD	Natural solid walnut wood/ Graphite finished metal Madera maciza de nogal natural/ Metal acabado grafito
Línea H Black Ash	LIHBGD	Black stained ash / Brass finished metal Fresno teñido negro / Metal acabado latón
Línea H Oak	LIHRBD	Natural solid oak wood/ Graphite finished metal Madera maciza de roble natural/ Metal acabado grafito

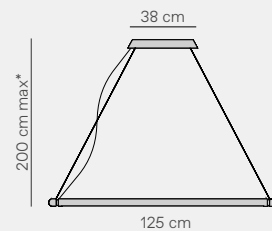

LÍNEA V

MODEL	REF.	Finishes / Acabado
Línea V Walnut-Gold	LIVNGD	Natural solid walnut wood/ Brass finished metal Madera maciza de nogal natural/ Metal acabado latón
Línea V Walnut-Black	LIVNBD	Natural solid walnut wood/ Graphite finished metal Madera maciza de nogal natural/ Metal acabado grafito
Línea V Black Ash	LIVBGD	Black stained ash / Brass finished metal Fresno teñido negro / Metal acabado latón
Línea V Oak	LIVRBD	Natural solid oak wood/ Graphite finished metal Madera maciza de roble natural/ Metal acabado grafito



LÍNEA D

MODEL	REF.	Finishes / Acabado
Línea D Walnut-Gold	LIDNGD	Natural solid walnut wood/ Brass finished metal Madera maciza de nogal natural/ Metal acabado latón
Línea D Walnut-Black	LIDNBD	Natural solid walnut wood/ Graphite finished metal Madera maciza de nogal natural/ Metal acabado grafito
Línea D Black Ash	LIDBGD	Black stained ash / Brass finished metal Fresno teñido negro / Metal acabado latón
Línea D Oak	LIDRBD	Natural solid oak wood/ Graphite finished metal Madera maciza de roble natural/ Metal acabado grafito

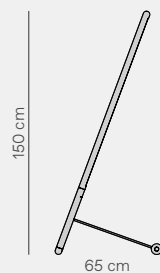

LÍNEA Uno

MODEL	REF.	Finishes / Acabado
Línea Uno Walnut-Gold	LIUNGSAD	Walnut / Brass finished metal / Sahara Noir marble Nogal / Metal acabado latón / Mármol Sahara Noir
Línea Uno Walnut-Black	LIUNBSAD	Walnut / Graphite finished metal / Sahara Noir marble Nogal / Metal acabado grafito / Mármol Sahara Noir
Línea Uno Black Ash	LIUBGSAD	Black Stained Ash / Brass finished metal / Sahara Noir marble Fresno teñido negro / Metal acabado latón / Mármol Sahara Noir
Línea Uno Oak	LIURBSAD	Oak / Graphite finished metal / Sahara Noir marble Roble / Metal acabado grafito / Mármol Sahara Noir

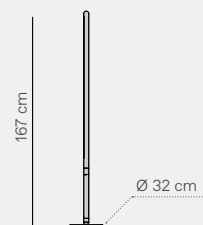

Marbles in stock: Emperador, Sahara Noir and Calacatta Gold.

Light source: LED Monocolor · DIMMABLE
Power: 14W
Nominal Luminous Flux: 1150lm
CRI: >95
Deviation (SDCM): 3 step MacAdam ellipse
Colour temperature: 2700K
Light emission 120°



LÍNEA H - SERIES CONNECTION

LÍNEA H SERIES 2

Natural solid walnut wood/ Brass finished metal
Madera maciza de nogal natural/ Metal acabado latón
Natural solid walnut wood/ Graphite finished metal
Madera maciza de nogal natural/ Metal acabado grafito

Cable to canopy
Cable a florón

CANOPY Single wood canopy
Unico florón de madera
WEIGHT 4kg / 8.8 lb
MODELS x2 Línea H

*Under request

REF.

CHLIHNG2

CHLIHNB2

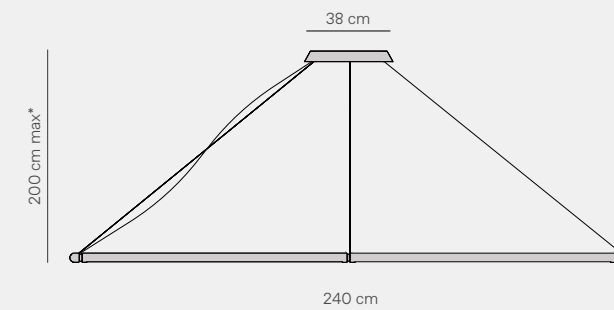

LÍNEA V - CHANDELIER CONFIGURATIONS

LÍNEA V CHANDELIER 2

Natural solid walnut wood/ Brass finished metal
Madera maciza de nogal natural/ Metal acabado latón
Natural solid walnut wood/ Graphite finished metal
Madera maciza de nogal natural/ Metal acabado grafito

Cable to canopy
Cable a florón

CANOPY Single wood canopy
Unico florón de madera
WEIGHT 4kg / 8.8 lb
MODELS x2 Línea H

*Under request

REF.

CHLIVNG2

CHLIVNB2

LÍNEA V CHANDELIER 3

Natural solid walnut wood/ Brass finished metal
Madera maciza de nogal natural/ Metal acabado latón
Natural solid walnut wood/ Graphite finished metal
Madera maciza de nogal natural/ Metal acabado grafito

Cable to canopy
Cable a florón

CANOPY Single wood canopy
Unico florón de madera
WEIGHT 5.5kg / 12.1 lb
MODELS x3 Línea V

*Under request

REF.

CHLIVNG3

CHLIVNB3

LÍNEA V CHANDELIER 4

Natural solid walnut wood/ Brass finished metal
Madera maciza de nogal natural/ Metal acabado latón
Natural solid walnut wood/ Graphite finished metal
Madera maciza de nogal natural/ Metal acabado grafito

Cable to canopy
Cable a florón

CANOPY Single wood canopy
Unico florón de madera
WEIGHT 7kg / 15.4 lb
MODELS x4 Línea V

*Under request

REF.

CHLIVNG4

CHLIVNB4

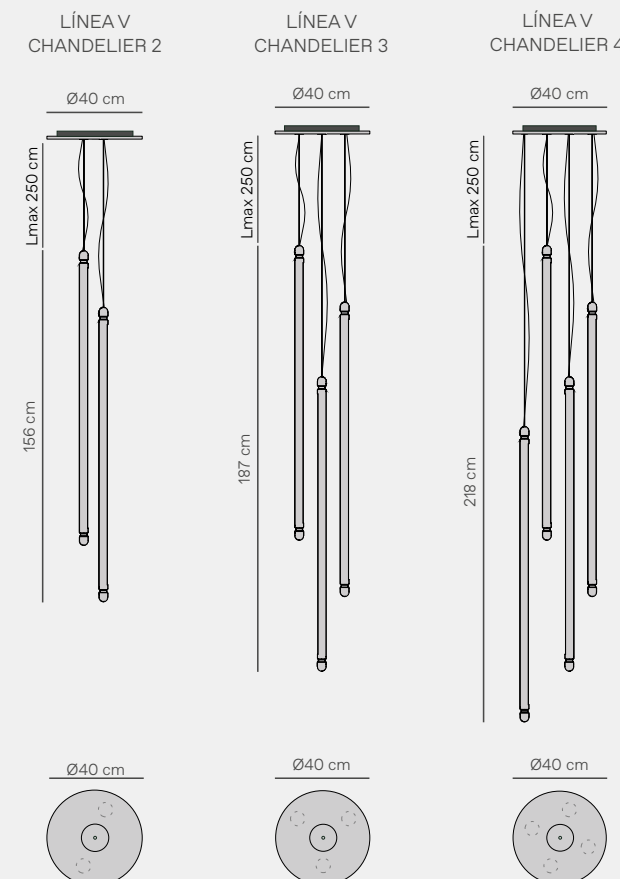

WOODEN DOTS

Cable: Gold or graphite finish
 Structure: Gold or graphite finished metal
 Dots: Natural solid walnut or lacquered solid wood

Cable: Color dorado o grafito
 Estructura: Metal acabado dorado o grafito
 Puntos: Madera de nogal natural o lacada

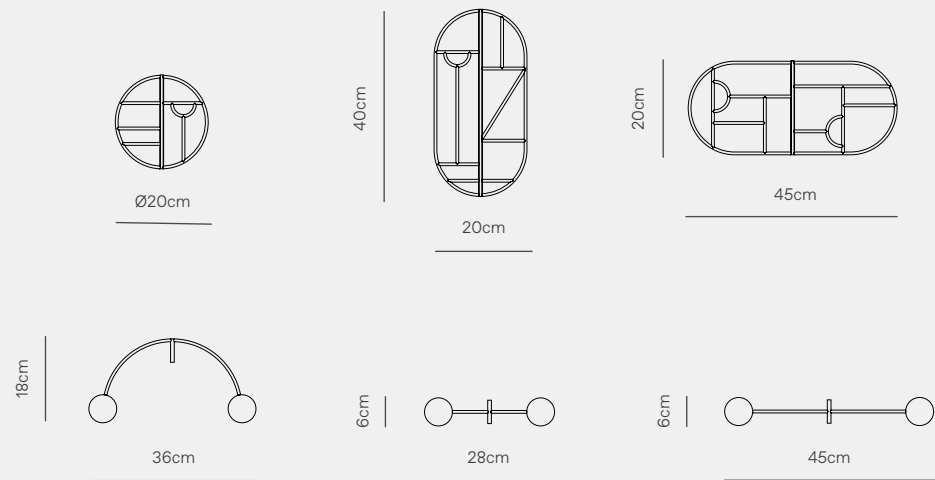

CONFIGURATIONS / CONFIGURACIONES

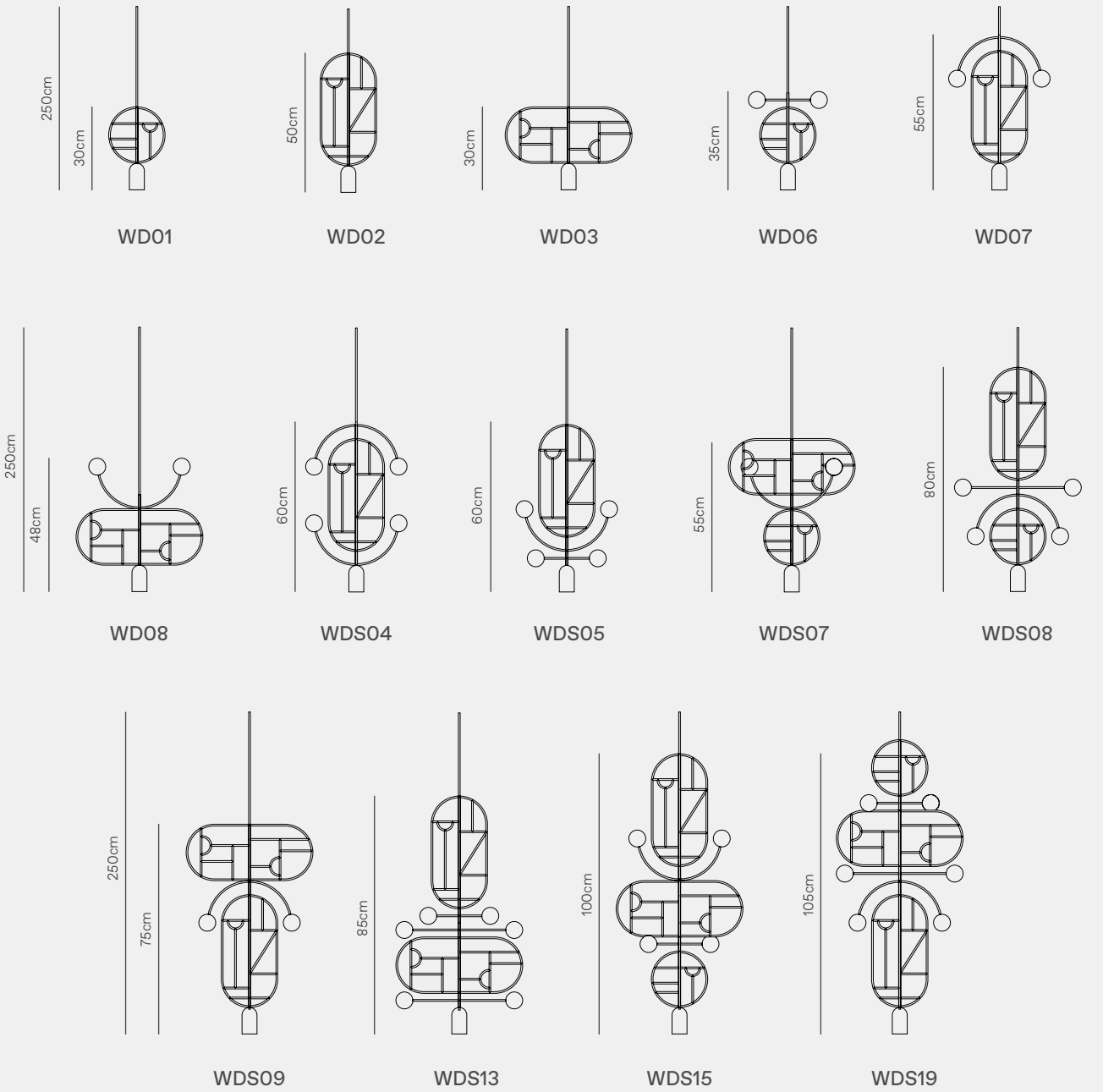

DIMMABLE (Dimmer not included)
 BULB: LED Reflector Par16 GU10 (included)
 Input voltage / Frequency: 100 - 240 V / 50 - 60 Hz (according to destination)
 Wattage: 7.5 W
 Lumens: 520 lm
 Colour Temperature: 2700K
 Angle: 60°



VIDEO
LIGHTING



ADMINISTRATION

T. (+34) 933 186 585 - ext.2
info@nomon.es

EXPORT

T. (+34) 933 186 585 - ext.3
export@nomon.es

TECHNICAL SERVICE

T. (+34) 933 186 585 - ext.1
produccion2@nomon.es

SOCIAL MEDIA

Instagram · nomon_clocks_home
Facebook & Pinterest · Nomon Clocks Home
communication@nomon.es



HEADQUARTERS

OFICINAS CENTRALES

Carrer Tucuman, 6 - 2nd floor
08030 BARCELONA
T. (+34) 933 186 585
F. (+34) 933 186 201

NOMON SHOWROOM

Passatge Maiol, 4
08013 BARCELONA
T. (+34) 936 638 497

HEADQUARTERS OPENING HOURS

HORARIO OFICINA

Lunes a Jueves / Monday to Thursday
09:00-17:00
Viernes / Fridays
08:00-16:00

SHOWROOM OPENING HOURS

HORARIO SHOWROOM

Visitas al showroom con cita previa.
Showroom visits by appointment only.

INSTAGRAM
ACCOUNT



WWW.NOMON.ES